

# LOCATION PLAN

GE BACKGROUND. SCALE 1:2500

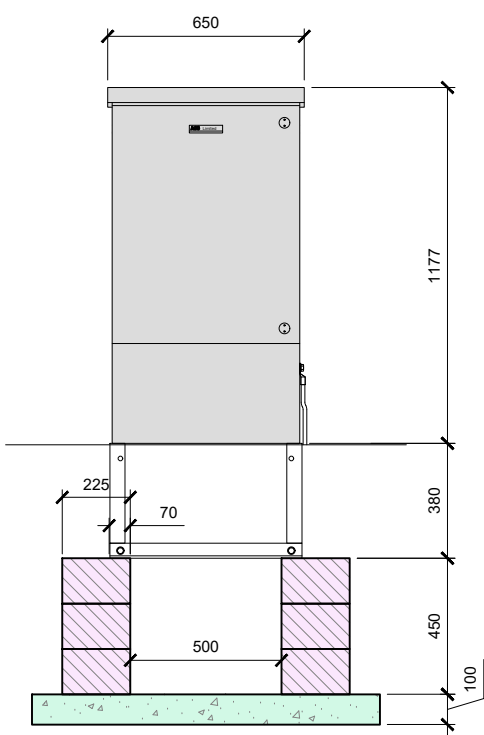

FRONT VIEW

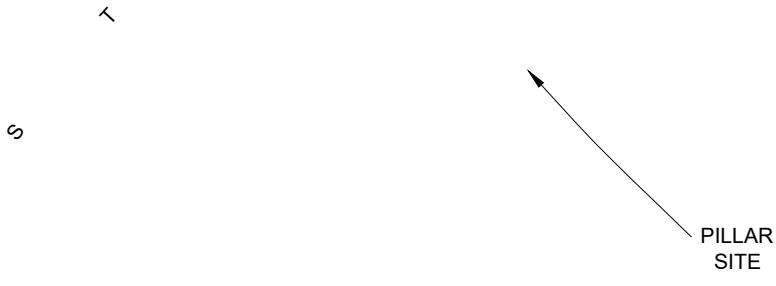
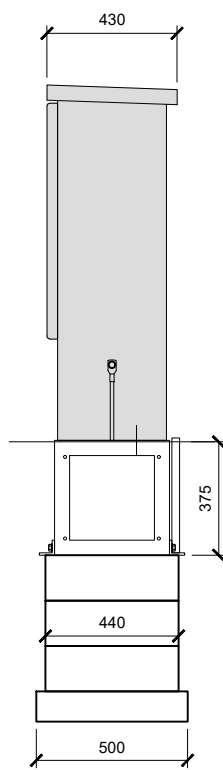

SIDE VIEW

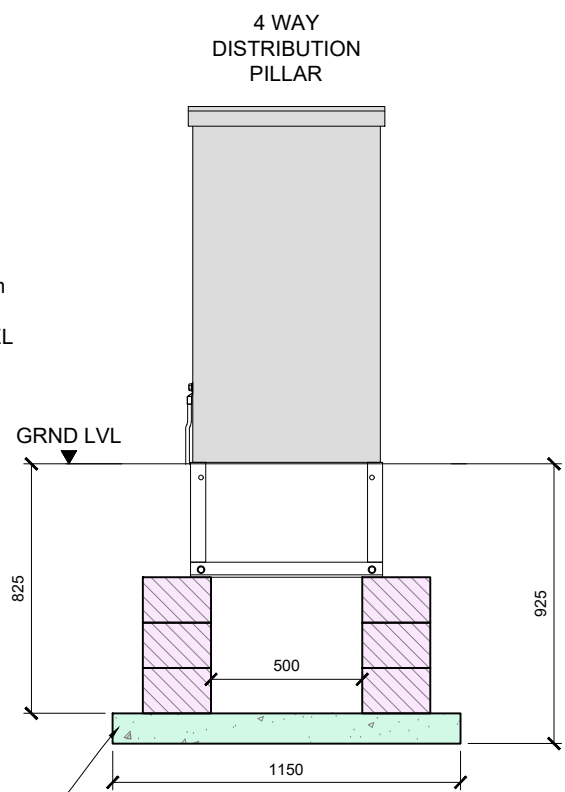

REAR VIEW

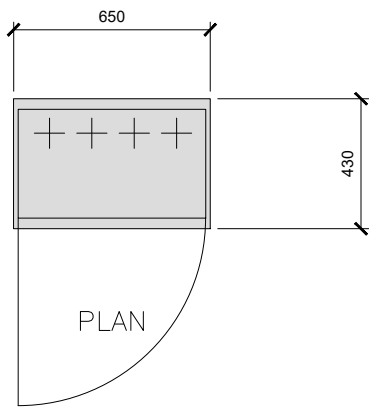

PLAN

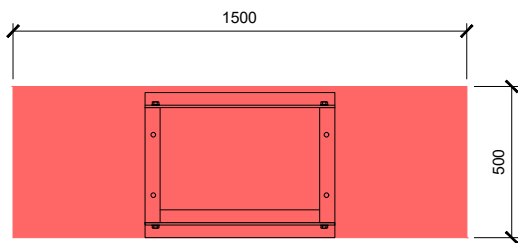

## STANDARD WAYLEAVE PLAN

SCALE 1:25

PILLAR CARCASE A  
NOMINAL 5mm  
ABOVE  
GROUND LEVEL

CONCRETE BLOCKS  
BEDDED ON GEN1  
CONCRETE  
FOUNDATIONS  
APPROX 500x400x100  
ON FIRM BASE

PILLAR WEIGHT 190Kg

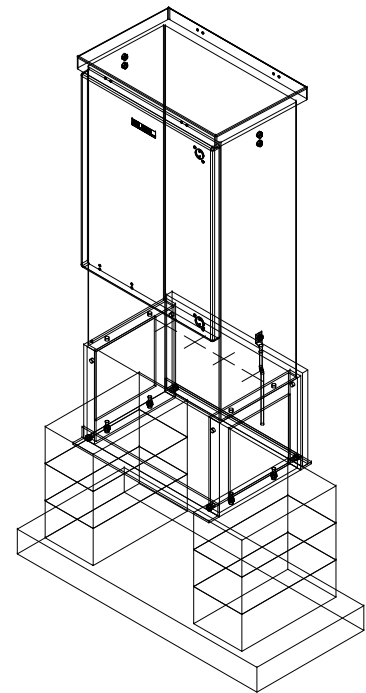

PILLAR FINISH  
AS PROVIDE FROM MANUFACTURER IN STAINLESS STEEL UNPAINTED

## PILLAR DETAIL

ABB 4 WAY DISTRIBUTION PILLAR



Guernsey Electricity Limited  
Registered Guernsey Company Nos 38692  
Registered Office:  
Electricity House, Northside, Vale,  
Guernsey GY1 3AD  
Tel: 01481-200700 Fax: 01481-246942

REV	DATE	DESCRIPTION	INT	APPR
<p>This is a Controlled maintained document. All copies printed, photocopied or via the internet will be deemed uncontrolled.</p>				
Drawing Status		<b>FOR APPROVAL</b>		
Discipline		CONSTRUCTION		

Where Designed	---	Where Drawn	RB 25/10/2019	Where Approved	---	Where Approved	01/01/1900
Where	09-0000	Where	P013507-SK01	Where	-		